



SVRA_LD-15WR2 & SVRB_LD-15WR2 SERIES

15W, WIDE INPUT, ISOLATED & REGULATED
DUAL/SINGLE OUTPUT DIP PACKAGING,
DC-DC CONVERTER

FEATURES

- Efficiency up to 90%
- 2:1 wide input voltage range
- Short circuit protection
- Output over current protection
- Output over voltage protection
- 1.5KVDC isolation
- Operating temperature range: -40°C ~ +85°C
- Six-sided metal shield
- Industry standard pinout
- Meet CISPR22/EN55022 CLASS A
- A2S(chassis mounting)andA4S(DIN-Rail mounting)have the function of input reverse connection preventing

PART NUMBER SYSTEM

SVRA1205LD-15WR2

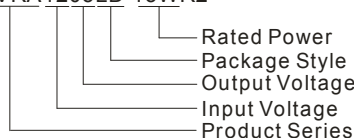

APPLICATION

SVRA_LD-15WR2 & SVRB_LD-15WR2 series are applied to wide voltage range input situation such as data transmission device, battery power supply device, telecommunication device, distributed power supply system, remote control system, industrial robot system etc.

SELECTION GUIDE

Model ^①	Input Voltage(VDC)		Output Voltage (VDC)	Output Current (mA)		Input Current (mA)(typ.)		Reflected Ripple Current (mA,typ.)	Max. Capacitive Load ^③ (μF)	Efficiency ^④ (% , typ.) @Max. Load
	Nominal (Range)	Max ^②		Max.	Min.	@Max. Load	@No Load			
SVRA1205LD-15WR2	12 (9-18)	20	±5	±1500	±75	1453	30	30	1020	86
SVRA1212LD-15WR2			±12	±625	±32	1420	25		495	88
SVRA1215LD-15WR2			±15	±500	±25	1420	25		165	88
SVRA1224LD-15WR2			±24	±313	±16	1420	20		200	88
SVRB1203LD-15WR2			3.3	4000	200	1465	65		10500	87
SVRB1205LD-15WR2			5	3000	150	1405	60		4020	89
SVRB1212LD-15WR2			12	1250	63	1405	25		1035	89
SVRB1215LD-15WR2			15	1000	50	1405	25		705	89
SVRB1224LD-15WR2			24	625	32	1389	30		250	90
SVRA2405LD-15WR2			24 (18-36)	40	±5	±1500	±75		727	25
SVRA2412LD-15WR2	±12	±625			±32	710	20	495	88	
SVRA2415LD-15WR2	±15	±500			±25	710	20	165	88	
SVRA2424LD-15WR2	±24	±313			±16	710	20	200	88	
SVRB2403LD-15WR2	3.3	4000			200	625	35	10500	88	
SVRB2405LD-15WR2	5	3000			150	695	35	4020	90	
SVRB2412LD-15WR2	12	1250			63	703	20	1035	89	
SVRB2415LD-15WR2	15	1000			50	695	20	705	90	
SVRB2424LD-15WR2	24	625			32	695	25	250	90	
SVRA4805LD-15WR2	48 (36-75)	80			±5	±1500	±75	363	20	1020
SVRA4812LD-15WR2			±12	±625	±32	355	15	495	88	

SVRA4815LD-15WR2		±15	±500	±25	355	15		165	88
SVRA4824LD-15WR2		±24	±313	±16	355	15		200	88
SVRB4803LD-15WR2		3.3	4000	200	316	35		10500	87
SVRB4805LD-15WR2		5	3000	150	360	35		4020	87
SVRB4812LD-15WR2		12	1250	63	352	25		1035	89
SVRB4815LD-15WR2		15	1000	50	348	15		705	90
SVRB4824LD-15WR2		24	625	32	352	15		250	89

Note: ①Series with suffix "H" are heat sink mounting; series with suffix "A2S" are chassis mounting, with suffix "A4S" are DIN-Rail mounting, for example SURB2405LD-15WHR2A2S is chassis mounting of with heat sink, SURB2405LD-15WR2A4S is DIN-Rail mounting of without heat sink; if the application has a higher requirement for heat dissipation, you can choose modules with heat sink;
 ②Absolute maximum rating without damage on the converter;
 ③For dual-output-converters the given value is for one output (for both outputs the same value);
 ④The efficiency of "A2S" and "A4S" is approx. 2% lower for the protection of inverse polarity.

INPUT SPECIFICATIONS

Item	Test Conditions	Min.	Typ.	Max.	Unit
Input Surge Voltage (1sec.max.)	12VDC input	-0.7	--	25	VDC
	24VDC input	-0.7	--	50	
	48VDC input	-0.7	--	100	
Start-up Voltage	12VDC input	--	--	9	
	24VDC input	--	--	17.8	
	48VDC input	--	--	35.8	
Under Voltage Shutdown	12VDC input	7.5	--	--	
	24VDC input	16	--	--	
	48VDC input	32	--	--	
Start-up Time	Nominal input& constant resistance load	--	10	--	
Ctrl*	Models ON	Ctrl open or connect TTL high level (2.5-12VDC)			
	Models OFF	Ctrl connect GND or low level (0-1.2VDC)			
	Input current (Models OFF)	--	1	--	mA
Input Filter		Pi Filter			

Note: *The Ctrl control pin voltage is refer to GND.

OUTPUT SPECIFICATIONS

Item	Test Conditions	Min.	Typ.	Max.	Unit
Positive Voltage Accuracy		--	±1	±3	%
Negative Voltage Accuracy					
Output Voltage Balance	Dual output, balanced loads	--	±0.5	±1	
Line Regulation	Full load, input voltage from low to high	--	±0.2	±0.5	
Load Regulation	5% to 100% load	--	±0.5	±1	
Cross Regulation	Dual output, main output 50% load, Supplement output from 5% to 100% load	--	--	±5	
Transient Recovery Time	25% load step change	--	300	500	µs
Transient Response Deviation		--	±3	±5	%
Temperature Drift	Full load	--	±0.02	--	%/°C
Ripple & Noise*	20MHz bandwidth	--	70	100	mVp-p
Trim		--	±10%	--	VDC
Output Over Voltage Protection	3.3VDC output	--	3.9	--	
	5VDC output	--	6.2	--	
	12VDC output	--	15	--	
	15VDC output	--	18	--	
	24VDC output	--	30	--	
Over Current Protection	Input voltage range	--	150	--	%
Short Circuit Protection		Hiccup, Continuous, automatic recovery			

Note: * Ripple and noise tested by "parallel cable" method. See detailed operation instructions at DC-DC Application Notes .

COMMON SPECIFICATIONS

Item	Test Conditions	Min.	Typ.	Max.	Unit
------	-----------------	------	------	------	------

Isolation Voltage	Input-Output, tested for 1 minute and leakage current less than 1 mA	1500	--	--	VDC
Isolation Resistance	Input-Output, test at 500VDC	1000	--	--	MΩ
Isolation Capacitance	Input-Output, 100KHz/0.1V	24VDC output	--	2000	pF
		Others	--	1000	
Switching Frequency	PWM mode	--	300	--	KHz
MTBF	MIL-HDBK-217F@25□	1000	--	--	K hours
Case Material		Aluminum Alloy			
Size	PCB mounting (Without heat sink)	50.80×25.40×11.80			mm
	PCB mounting (With heat sink)	50.80×25.40×16.30			
	A2S Chassis mounting (Without heat sink)	76.00×31.50×21.20			
	A2S Chassis mounting (With heat sink)	76.00×31.50×25.10			
	A4S DIN-Rail mounting (Without heat sink)	76.00×31.50×25.80			
	A4S DIN-Rail mounting (With heat sink)	76.00×31.50×29.70			
Weight	PCB mounting (Without heat sink)	--	28	--	g
	PCB mounting (With heat sink)	--	36	--	
	A2S Chassis mounting (Without heat sink)	--	50	--	
	A2S Chassis mounting (With heat sink)	--	58	--	
	A4S DIN-Rail mounting (Without heat sink)	--	70	--	
	A4S DIN-Rail mounting (With heat sink)	--	78	--	

ENVIRONMENTAL SPECIFICATIONS

Item	Test Conditions	Min.	Typ.	Max.	Unit
Storage Humidity	Non condensing	5	--	95	%
Operating Temperature	See Temperature Derating Curve (Figure 3)	-40	--	85	°C
Storage Temperature		-55	--	125	
The Max. Case Temperature	Operating Temperature curve range	--	--	105	
Lead Temperature	1.5mm from case for 10 seconds	--	--	300	
Cooling		Free air convection			
Vibrating		10-55Hz, 10G, 30 Min. along X, Y and Z			

EMC SPECIFICATIONS

EMI	CE	CISPR22/EN55022 CLASS A (Without External Circuit) / CLASS B (External Circuit Refer to Figure1-□)			
	RE	CISPR22/EN55022 CLASS A (Without External Circuit) / CLASS B (External Circuit Refer to Figure1-□)			
EMS	ESD	IEC/EN61000-4-2	Contact ±4KV	perf. Criteria B	
	RS	IEC/EN61000-4-3	10V/m	perf. Criteria A	
	EFT	IEC/EN61000-4-4	±2KV (External Circuit Refer to Figure1-□)	perf. Criteria B	
	Surge	IEC/EN61000-4-5	±2KV (External Circuit Refer to Figure1-□)	perf. Criteria B	
	CS	IEC/EN61000-4-6	3 Vr.m.s	perf. Criteria A	
	Voltage dips, short and interruptions immunity	IEC/EN61000-4-29	0%-70%	perf. Criteria B	

EMC RECOMMENDED CIRCUIT

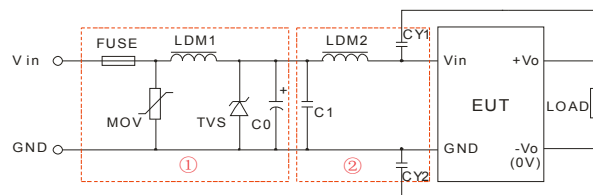

(Figure 1)

Note: 1. In Figure 1, part □ is EMS recommended external circuit, part □ is EMI recommended external circuit. Choose according to requirements.

2. If there is no recommended parameters, the model no require the external component.

Recommended external circuit parameters:

Model	Vin:12V	Vin:24V	Vin:48V
FUSE	Choose according to practical input current		
MOV	--	S14K35	S14K60
LDM1	--	56μH	
TVS	SMCJ28A	SMCJ48A	SMCJ90A
C0	680μF/25V	330μF/50V	330μF/100V
C1	1μF /50V	1μF /50V	1μF /100V
LDM2	4.7μH		
CY1, CY2	1nF/2KV		

EMC RECOMMENDED CIRCUIT PCB LAYOUT

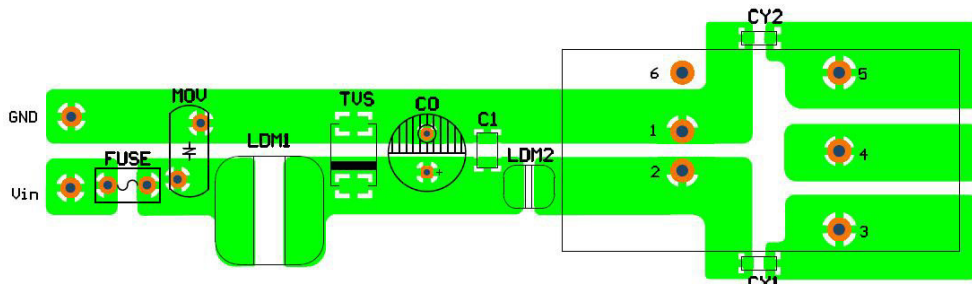

(Figure 2)

Note: The pad space between input and output (CY1/CY2) must $\geq 2\text{mm}$.

EMC TEST WAVEFORM(CLASS B TEST CIRCUIT)

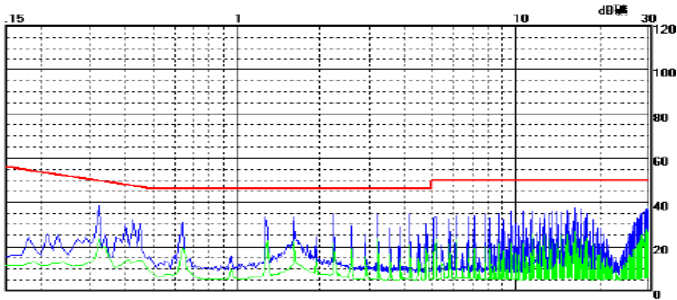

SVRA2405LD-15WR2 CE (Positive line)

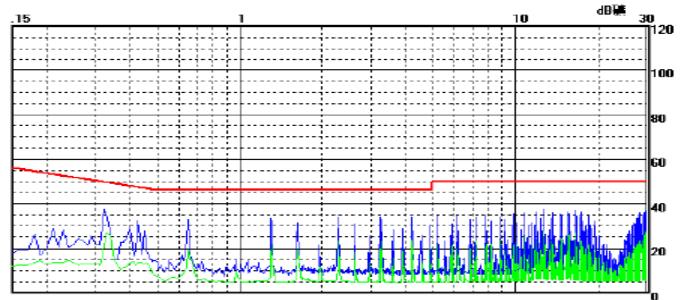

SVRA2405LD-15WR2 CE (Negative line)

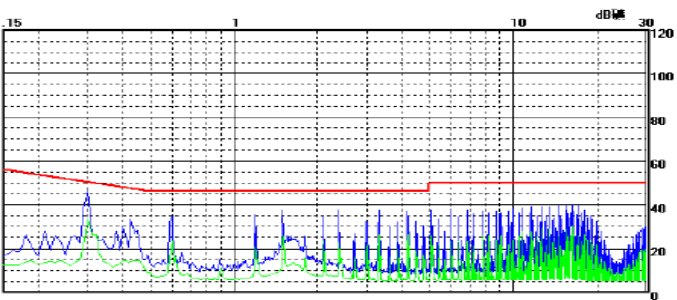

SVRA4815LD-15WR2 CE (Positive line)

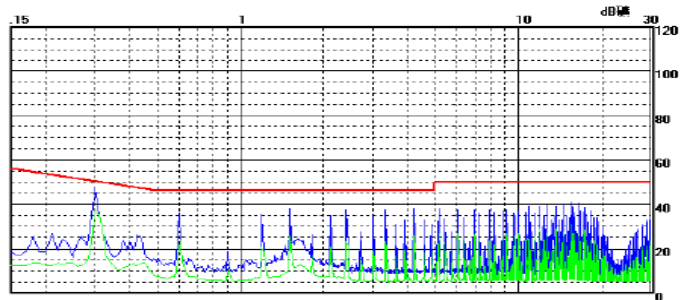

SVRA4815LD-15WR2 CE (Negative line)

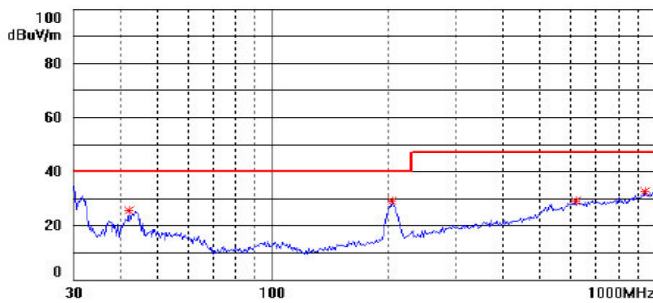

SVRA2405LD-15WR2 RE(Horizontal)

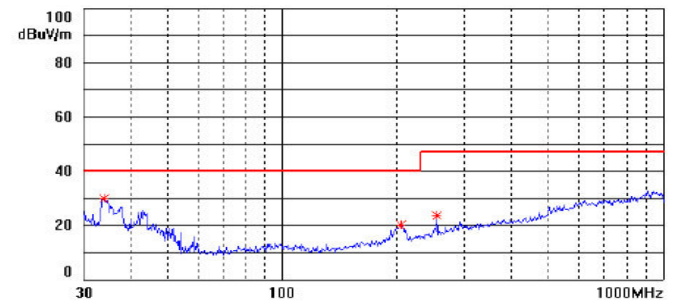

SVRA2405LD-15WR2 RE(Vertical)

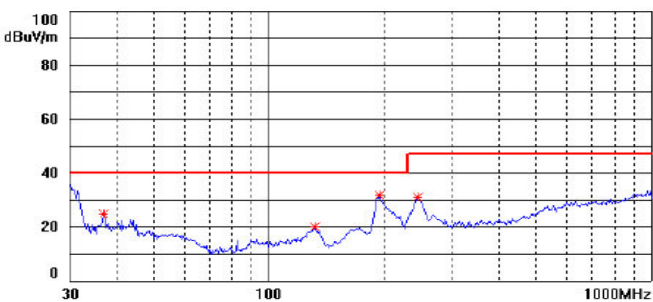

SVRA4815LD-15WR2 RE(Horizontal)

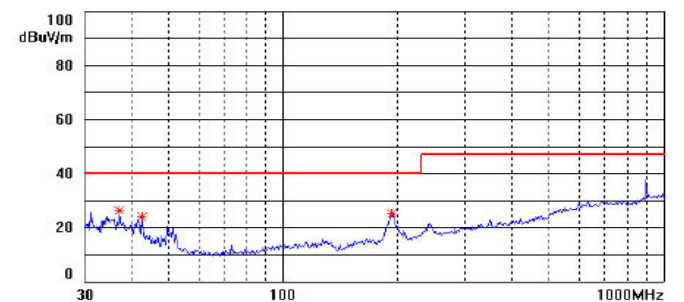

SVRA4815LD-15WR2 RE(Vertical)

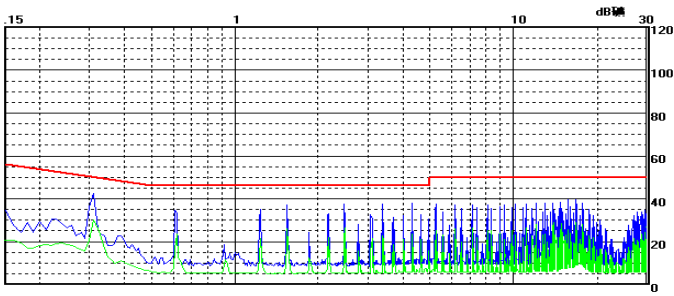

SVRB4815LD-15WR2 CE (Positive line)

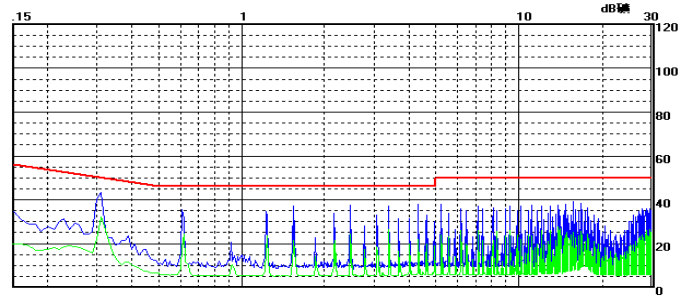

SVRB4815LD-15WR2 CE (Negative line)

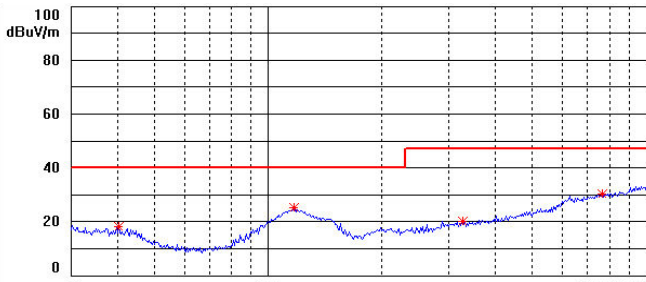

SVRB2405LD-15WR2 RE(Horizontal)

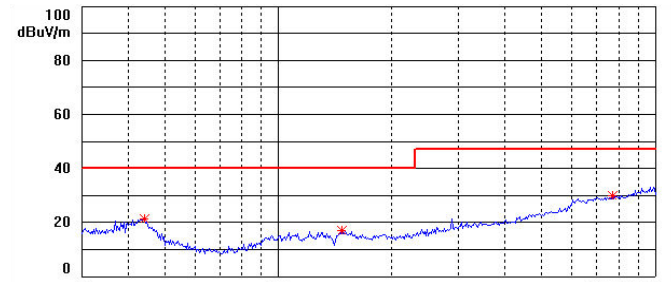

SVRB2405LD-15WR2 RE(Vertical)

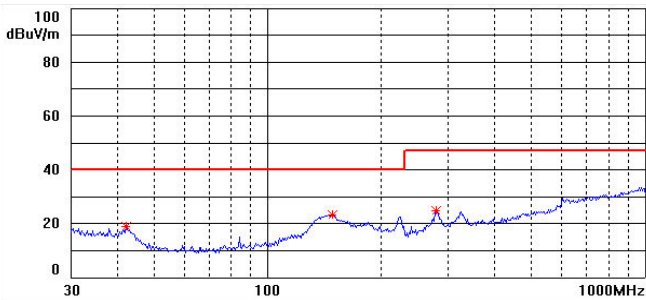

SVRB4815LD-15WR2 RE(Horizontal)

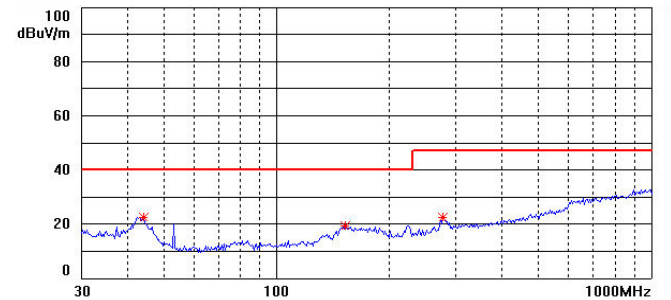

SVRB4815LD-15WR2 RE(Vertical)

PRODUCT TYPICAL CURVE

Temperature Derating Curve

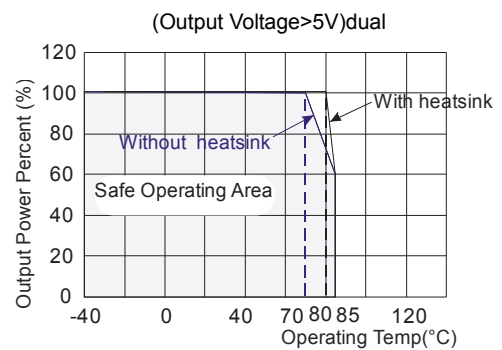
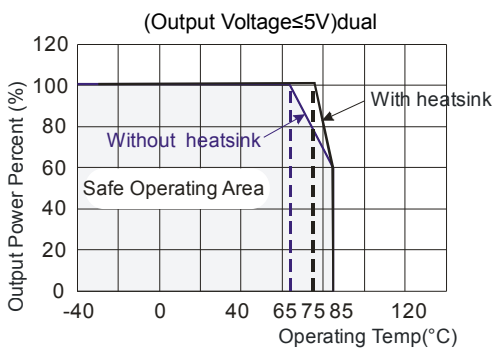
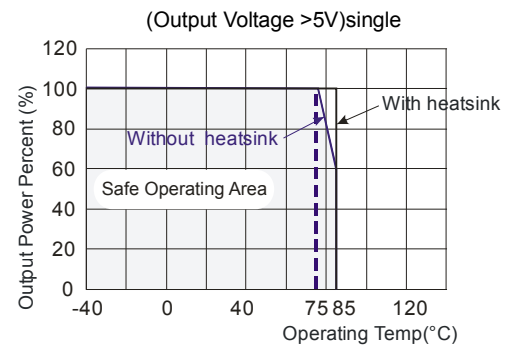
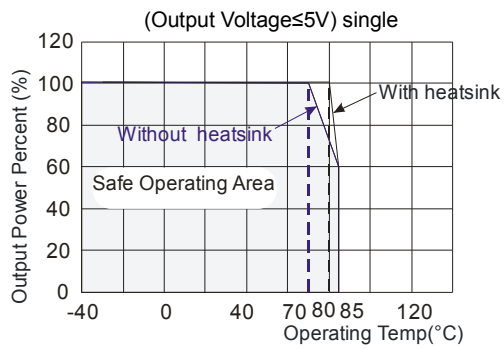

(Figure 3)

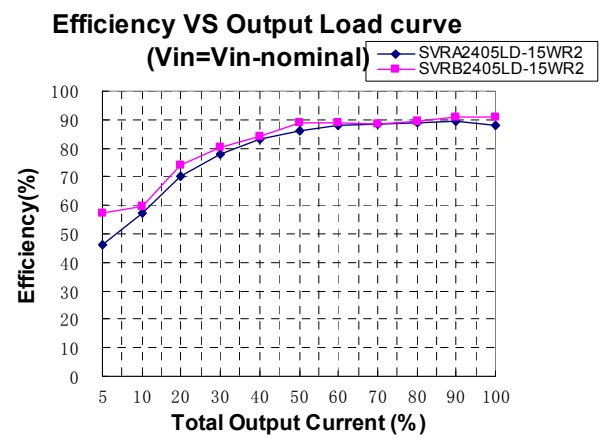
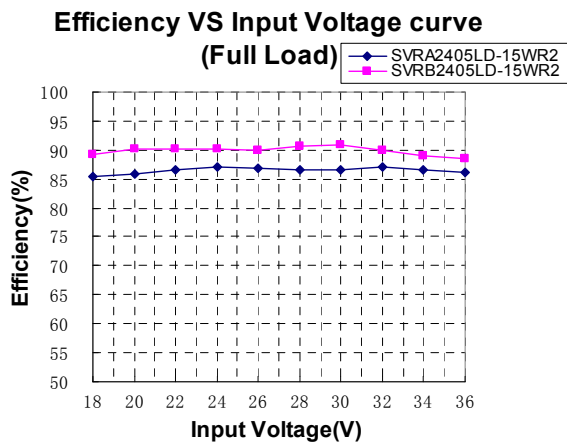
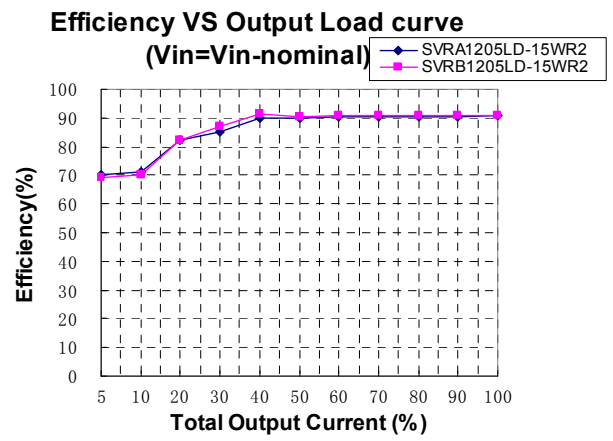
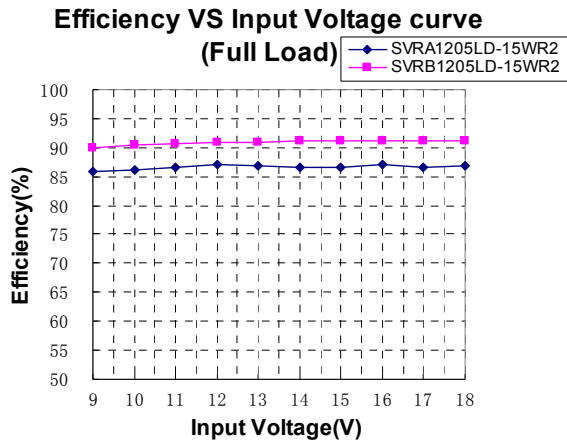

PCB MOUNTING OUTLINE DIMENSIONS, RECOMMENDED FOOTPRINT(WITHOUT HEATSINK)

MECHANICAL DIMENSIONS

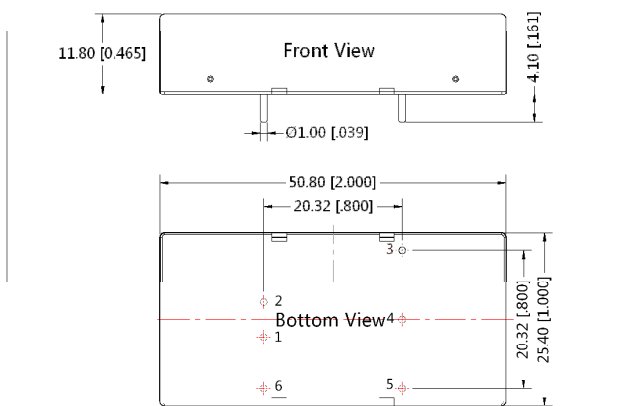

Note:
 Unit :mm[inch]
 Pin diameter tolerances :±0.10mm[±0.004inch]
 Pin height tolerances :±0.50mm[±0.020inch]
 General tolerances:±0.30mm[±0.012inch]



RECOMMENDED FOOTPRINT DETAILS

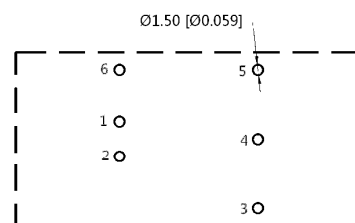

Note : Grid 2.54*2.54mm

Pin	PIN CONNECTION	
	Single	Dual
1	GND	GND
2	Vin	Vin
3	+Vo	+Vo
4	Trim	0V
5	0V	-Vo
6	Ctrl	Ctrl

PCB MOUNTING OUTLINE DIMENSIONS(WITH HEATSINK)

MECHANICAL DIMENSIONS(WITH HEATSINK)

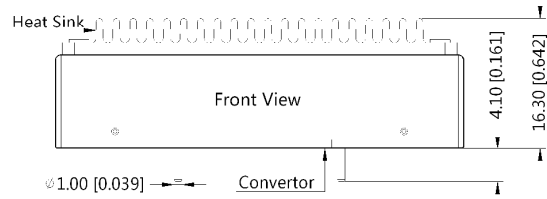
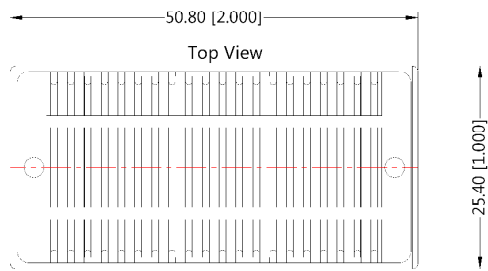

Note:
 Unit :mm[inch]
 General tolerances:±0.30mm[±0.012inch]
 If use heatsinks,make sure there is enough space for a special size in ther above graph.

SVRA_LD-15WR2A2S & SVRB_LD-15WR2A2S CHASSIS MOUNTING OUTLINE DIMENSIONS

MECHANICAL DIMENSIONS

Footprint Details						
Pin	1	2	3	4	5	6
Dual	Ctrl	GND	Vin	-Vo	0V	+Vo
Single	Ctrl	GND	Vin	0V	Trim	+Vo

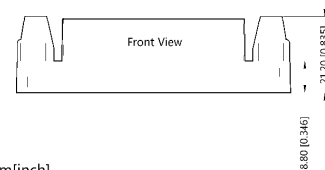
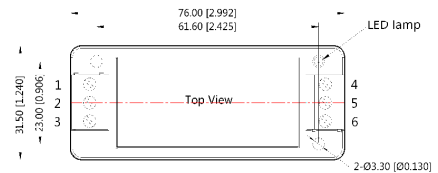

Note:
 Unit:mm[inch]
 Wire range : 24~12 AWG
 If use heat sink,the product height is 25.70[1.012]
 General tolerances:±0.5mm[±0.02inch]

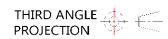

SVRA_LD-15WR2A4S & SVRB_LD-15WR2A4S DIN-RAIL MOUNTING OUTLINE DIMENSIONS

DIN-rail modules are fitting to TS35 rails

Footprint Details						
Pin	1	2	3	4	5	6
Dual	Ctrl	GND	Vin	-Vo	0V	+Vo
Single	Ctrl	GND	Vin	0V	Trim	+Vo

MECHANICAL DIMENSIONS

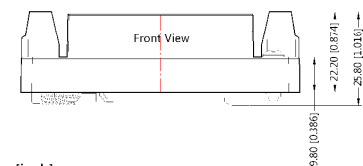
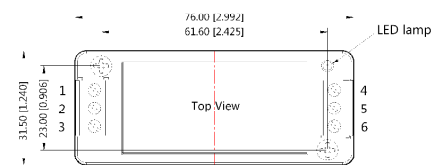

Note:
 Unit:mm[inch]
 Wire range : 24~12 AWG
 If use heat sink,the product height is 30.30[1.193]
 General tolerances:±0.5mm[±0.02inch]



PACKAGE DIAGRAM

PCB mounting Series (Without heat sink)

TUBE PACKAGING DIMENSIONS (WITHOUT HEATSINK)

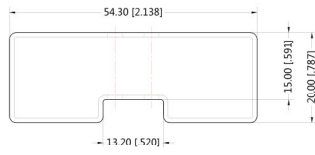

Note:
Unit :mm[inch]
General tolerances :±0.5mm[±0.020inch]
L=230mm[9.055 inch] Tube Quantity:7 pcs
Inner carton(S): L*W*H=255*170*80 mm;
Outer carton(S): L*W*H=375*280*270mm, 6 inner cartons(S);

PCB mounting Series (With heat sink)

TUBE PACKAGING DIMENSIONS (WITH HEATSINK)

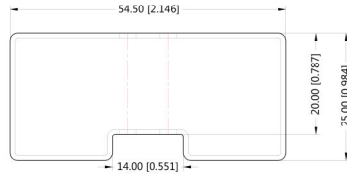

Note:
Unit :mm[inch]
General tolerances :±0.50mm[±0.020inch]
L=220mm[8.661inch] Tube Quantity: 7pcs
Inner carton(S): L*W*H=255*170*80 mm;
Outer carton(S): L*W*H=375*280*270mm, 6 inner cartons(S);

Special Package Series (A2S/A4S)

PACKAGE DIAGRAM

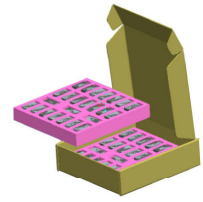

Note:
Inner carton dimensions L*W*H=365*350*105mm
Packaging quantity : 48 PCS
Outer carton dimensions: L*W*H=390*360*245mm
Packaging quantity : 96 PCS

TEST CONFIGURATIONS

Input Reflected-Ripple Current Test Setup

Input reflected-ripple current is measured with an inductor L_{in} and Capacitor C_{in} to simulate source impedance.

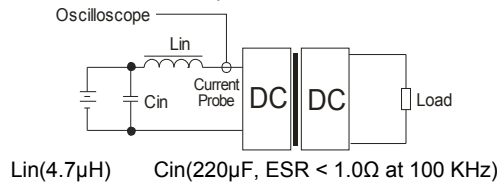

TRIM APPLICATION & TRIM RESISTANCE

Application circuit for TRIM (Part in broken line is the interior of models)

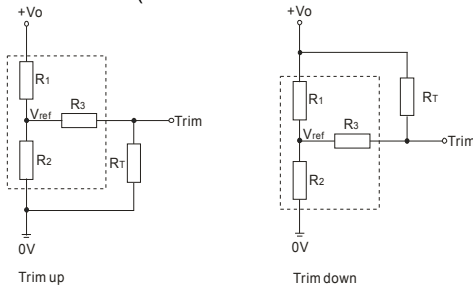

Formula for resistance of TRIM

$$\begin{aligned} \text{up: } R_T &= \frac{aR_2}{R_2 - a} - R_3 & a &= \frac{V_{ref}}{V_o' - V_{ref}} \cdot R_1 \\ \text{down: } R_T &= \frac{aR_1}{R_1 - a} - R_3 & a &= \frac{V_o' - V_{ref}}{V_{ref}} \cdot R_2 \end{aligned}$$

Note: Leave open if not used. Value for R_1 , R_2 , R_3 , and V_{ref} refer to the above table 1. R_T : Resistance of Trim. a : User-defined parameter, no actual meanings. V_o' : The trim up/down voltage.

(Table 1)

V_o Parameter	3.3(VDC)	5(VDC)	12(VDC)	15(VDC)	24 (VDC)
$R_1(K\Omega)$	4.801	2.883	10.971	14.497	24.872
$R_2(K\Omega)$	2.863	2.864	2.864	2.864	2.863
$R_3(K\Omega)$	15	10	17.8	17.8	20
$V_{ref}(V)$	1.24	2.5	2.5	2.5	2.5

DESIGN CONSIDERATIONS

Recommended circuit

All the SVRA_LD-15WR2 & SVRB_LD-15WR2 Series have been tested according to the following recommended testing circuit before leaving factory. This series should be tested under load. Never be tested under no load (see Figure 4).

If you want to further decrease the input surge voltage and the output ripple, you can increase a capacitance properly or choose capacitors with low ESR. It should also be noted that the capacitance of filter capacitor must be proper. If the capacitance is too big, a startup problem might arise. For every channel of output, provided the safe and reliable operation is ensured, the recommended capacitance of its filter capacitor sees (Table 2).

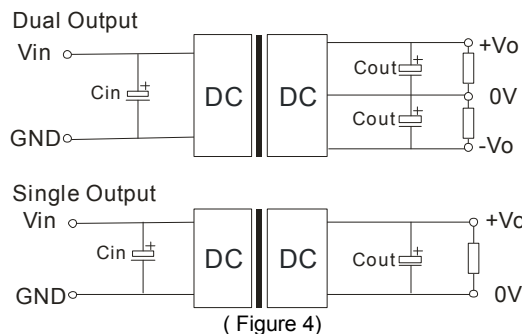

EXTERNAL CAPACITOR TABLE (Table 2)

Single Vout (VDC)	Cout (μF)	Cin (μF)	Dual Vout (VDC)	Cout# (μF)	Cin (μF)
3.3/5	470	100	±5	220	100
12/15	220		±12/±15	100	
24	100		±24	47	

Note: # For each output.

□ **It is not recommended to increase the output power capability by connecting two or more converters in parallel. The product is not hot-swappable.**

Note:

1. Min. load shouldn't be less than 5%, otherwise ripple may increase dramatically. Operation under minimum load will not damage the converter, however, they may not meet all specification listed.
2. Max. Capacitive Load tested at nominal input voltage and constant resistive load .
3. All specifications measured at Ta=25°C, humidity<75%, nominal input voltage and rated output load unless otherwise specified.
4. In this datasheet, all the test methods of indications are based on our corporate standards.
5. All characteristics are for listed model, non-standard models may perform differently, please contact our technical person for more detail.
6. Contact us for your specific requirement.
7. Specifications subject to change without prior notice.