

ST1 Series

SCHMID-M

1W High temperature Single & Dual output

Features

- 7 Pin SIL Package
- 1500 VDC Isolation
- Up to 3000 VDC Isolation
- Continuous Short Circuit Protection
- Low Ripple and Noise
- Efficiency up to 81%
- -40 ~ 105°C Operation Temperature Range
- Non-Conductive Black Plastic Case

The ST1 series is a family of high operation temperature 1W single & dual output DC-DC converters. These converters achieve low cost, high efficiency, extra high temperature operation, continuous short circuit protection and SIP 7 pin size. Devices are encapsulated using flame retardant resin. The models operate from input voltage of 5, 12, 24 Vdc with output voltage of 5, 12, 15, ±5, ±12, ±15 Vdc.

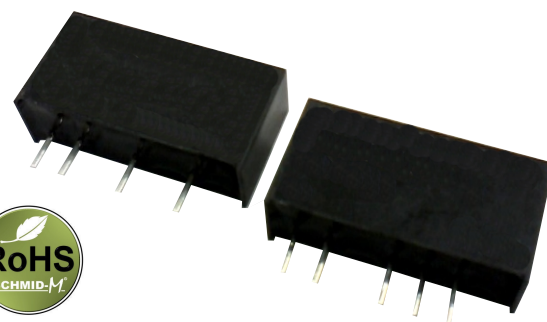

All specifications typical at Ta=25°C, nominal input voltage and full load unless otherwise specified

OUTPUT SPECIFICATIONS	
Voltage accuracy	See tolerance envelope curve
Ripple & noise (20 MHz bandwidth)(1)	75mV pk-pk
Line regulation	±1.2% / Per 1% Vin Change
Load regulation(From 10% to 100% Load)	Output 5VDC 10% Other Output 7.5%
Cross Regulation (Dual Output) (2)	±4%
Temperature coefficient	±0.02%/°C
Short Circuit Protection	Continuous, auto recovery
Capacitor load(3)	See table

INPUT SPECIFICATIONS	
Voltage Range	±11%
Input Current	See table, typ.
No-Load Input Current	See table, typ.
Input Filter	Capacitors
Input Reflected Ripple Current (4)	15mA pk-pk
Start up Time (Nominal Vin and constant resistive load)	20mS, typ.

GENERAL SPECIFICATIONS	
Efficiency	See table
I/O Isolation Voltage(60 sec) Input/Output	1500~3000Vdc
I/O Isolation Capacitance	50 pF Typ.
I/O Isolation Resistance	1G Ohm
Switching Frequency	Variable 50kHz
Humidity	95% rel H
Reliability Calculated MTBF(MIL-HDBK-217 F)	>3.6 Mhrs.
Safety Standard : (designed to meet)	IEC 60950-1
Environmental compliance	RoHS

EMC SPECIFICATIONS (designed to meet) (1)		
Radiated Emissions	EN55022	CLASS B
Conducted Emission(5)	EN55022	CLASS B
ESD	IEC 61000-4-2	Perf. Criteria A
RS	IEC 61000-4-3	Perf. Criteria A
EFT	IEC 61000-4-4	Perf. Criteria A
SURGE(6)	IEC 61000-4-5	Perf. Criteria A
CS	IEC 61000-4-6	Perf. Criteria A
PPMF	IEC 61000-4-8	Perf. Criteria A

PHYSICAL SPECIFICATIONS	
Case Material	Non-conductive Black Plastic(UL94V-0 rated)
Pin Material	C5191R-H Solder-coated
Potting Material	Epoxy (UL94V-0 rated)
Weight	2.4g, Typ
Dimensions	SIP Case 0.76"x0.24"x0.39"

ENVIRONMENT SPECIFICATIONS	
Operating Temperature	-40°C~105°C(See Derating Curve)
Maximum Case Temperature	115°C
Storage Temperature	-55°C~125°C
Cooling	Nature Convection

ABSOLUTE MAXIMUM RATINGS(6)	
These are stress ratings. Exposure of devices to any of these conditions may adversely affect long-term reliability.	
Input Voltage(1Sec)	
5 Modes	9 Vdc, max.
12 Modes	18 Vdc, max.
24 Modes	30 Vdc, max.
Soldering Temperature (1.5mm from case 10 sec.)	260°C, max.

NOTE

1. Ripple/Noise measured with a 0.1 uF ceramic capacitor.
2. One load is 25% to 100% load, the other load is 100% load, the output voltage variable rate is within ±4%.
3. Tested by minimal Vin and constant resistive full load.
4. Measured Input reflected ripple current with a simulated source inductance of 12uH and a source capacitor Cin(47uF, ESR<1.0Ω at 100KHz).
5. Input filter components (C1, L) are used to help meet conducted emissions requirement for the module. These components should be mounted as close as possible to the module; and all leads should be minimized to decrease radiated noise.
6. Input components (C2,D1) are used to help meet surge test requirement for the module. C2 and D1 recommended nichicon HE series and Lision 3.0SMCJ series.
7. Exceeding the absolute ratings of the unit could cause damage. It is not allowed for continuous operating.

ST1 - 1W High Temperature Single & Dual output

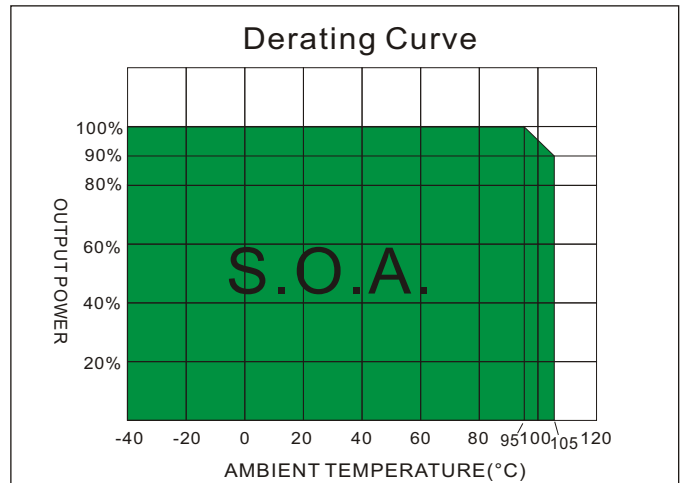
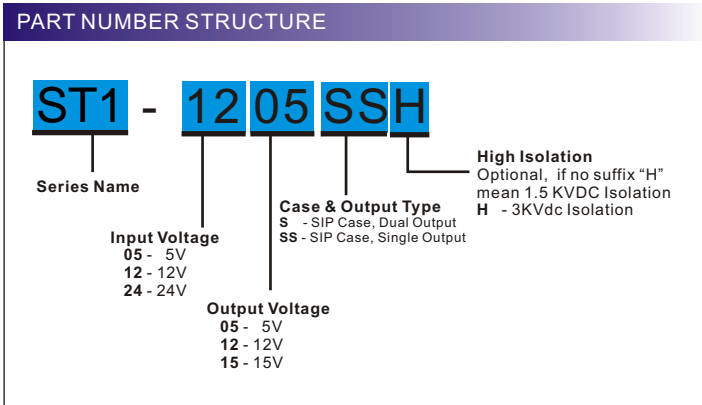

MODEL SELECTION GUIDE

MODEL NUMBER	INPUT Voltage Range (Vdc)	INPUT Current		OUTPUT Voltage (Vdc)	OUTPUT Current Full load (mA)	EFFICIENCY @FL(%)	Capacitor Load(µF)
		No-Load (mA)	Full Load (mA)				
ST1-0505SS	5 (4.5 ~ 5.5)	33	253	5	200	80	220
ST1-0512SS	5 (4.5 ~ 5.5)	33	253	12	83.3	80	100
ST1-0515SS	5 (4.5 ~ 5.5)	33	253	15	66.7	80	100
ST1-1205SS	12 (10.8 ~ 13.2)	15	105	5	200	80	220
ST1-1212SS	12 (10.8 ~ 13.2)	15	105	12	83.3	80	100
ST1-1215SS	12 (10.8 ~ 13.2)	15	104	15	66.7	81	100
ST1-2405SS	24 (21.6 ~ 26.4)	7	53	5	200	80	220
ST1-2412SS	24 (21.6 ~ 26.4)	7	53	12	83.3	80	100
ST1-2415SS	24 (21.6 ~ 26.4)	7	53	15	66.7	80	100
ST1-0505S	5 (4.5 ~ 5.5)	33	253	±5	±100	80	±100
ST1-0512S	5 (4.5 ~ 5.5)	33	253	±12	±41.67	80	±47
ST1-0515S	5 (4.5 ~ 5.5)	33	250	±15	±33.33	81	±47
ST1-1205S	12 (10.8 ~ 13.2)	15	105	±5	±100	80	±100
ST1-1212S	12 (10.8 ~ 13.2)	15	105	±12	±41.67	80	±47
ST1-1215S	12 (10.8 ~ 13.2)	15	105	±15	±33.33	80	±47
ST1-2405S	24 (21.6 ~ 26.4)	7	53	±5	±100	80	±100
ST1-2412S	24 (21.6 ~ 26.4)	7	53	±12	±41.67	80	±47
ST1-2415S	24 (21.6 ~ 26.4)	7	53	±15	±33.33	80	±47

Suffix "H" means 3 K Vdc isolation

Input Reflected Ripple Current Test Step

Input reflected ripple current is measured through a source inductor L_{in} (12uH) and a source capacitor C_{in} (47uF, ESR<1.0Ω at 100KHz) at nominal input and full load.

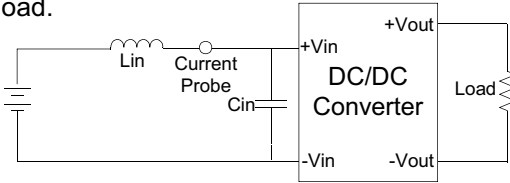

Output Voltage Tolerance Envelope Curve

The voltage tolerance envelope shows typical load regulation characteristics for this product series. The tolerance envelope is the maximum output voltage variation due to changes in output loading.

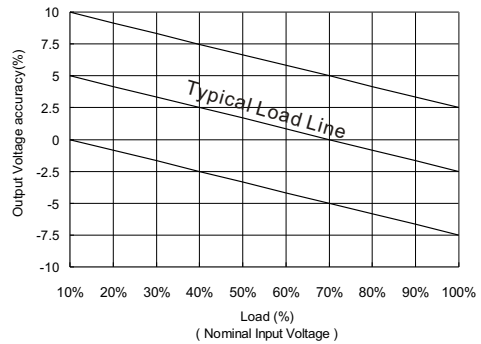

Output Ripple & Noise Measurement Test

Use a capacitor C_{out} (0.1uF) measurement. The Scope measurement bandwidth is 0-20MHz.

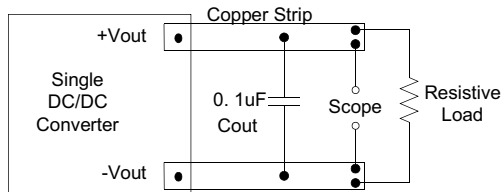

EMI Filter

Input filter components ($C1, L$) are used to help meet conducted emissions requirement for the module. These components should be mounted as close as possible to the module; and all leads should be minimized to decrease radiated noise.

SURGE Filter

Input components ($C2, D1$) are used to help meet surge test requirement for the module.

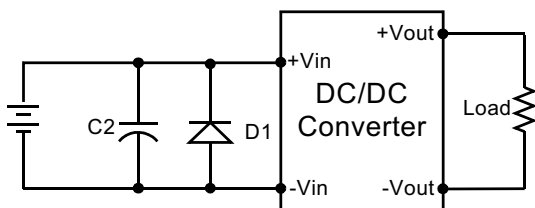

	C2	D1
ST1-05XXXX	1000uF/100V	3.0SMCJ9.0AG
ST1-12XXXX	680uF/100V	3.0SMCJ18AG
ST1-24XXXX	330uF/100V	3.0SMCJ28AG

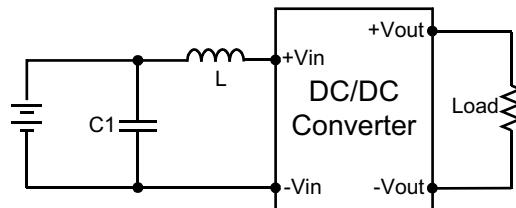

	C1	L
ST1-05XXXX	1206, 4.7uF/50V	6.8uH
ST1-12XXXX	1206, 4.7uF/50V	6.8uH
ST1-24XXXX	1206, 4.7uF/50V	6.8uH

MECHANICAL SPECIFICATIONS

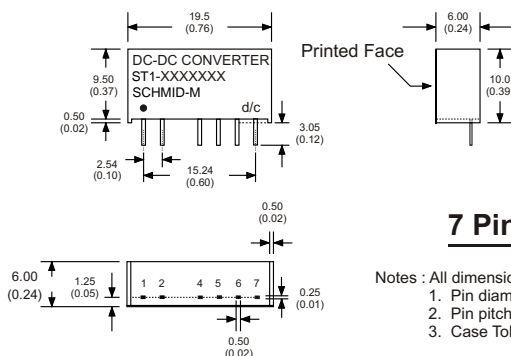

7 Pin SIL Package

- Notes: All dimensions are typical in millimeters (inches).
1. Pin diameter: 0.5 ± 0.05 (0.02 ± 0.002)
 2. Pin pitch and length tolerance: ± 0.35 (± 0.014)
 3. Case Tolerance: ± 0.5 (± 0.02)

PIN CONNECTIONS

PIN NUMBER	SINGLE	DUAL	SINGLE-H	DUAL-H
1	+V Input	+V Input	+V Input	+V Input
2	-V Input	-V Input	-V Input	-V Input
4	-V Output	-V Output	N.P.	N.P.
5	N.P.	Common	-V Output	-V Output
6	+V Output	+V Output	N.P.	Common
7	N.P.	N.P.	+V Output	+V Output