

SCHMID-M

ST-40W Series

40W 2:1 Regulated Single & Dual output

Features

- Wide 2:1 Input Range
- 1600 VDC Isolation
- Efficiency up to 92%
- Extended Operating Temperature Range -40 ~ 71°C max.
- Adjustable Output Voltage
- Remote On/Off Control (CTRL)
- Continuous Short Circuit Protection
- Over Load Protection
- Over Voltage Protection
- Soft Start
- High Power Density: 40W in 2"x1"x0.4" package
- No Minimum Load Required



The ST-40W series is a family of cost effective 40W single & dual output DC-DC converters. These converters combine nickle-coated copper package in a 2"x1" case with high performance features such as Active Clamp Technology, continuous short circuit protection with automatic restart and tight line/ load regulation. Devices are encapsulated using flame retardant resin. Input voltages of 12 and 24 and 48 with output voltage of 3.3, 5, 12, 15, ± 12 , ± 15 Vdc. High performance features include high efficiency operation up to 92%.

ALL SPECIFICATIONS ARE TYPICAL AT 25°C, NOMINAL INPUT AND FULL LOAD UNLESS OTHERWISE NOTED.

OUTPUT SPECIFICATIONS	
Output Voltage Accuracy	Single&Dual: $\pm 1\%$
Output Voltage Adjustability (Single Output Only)	$\pm 10\%$, max.
Maximum Output Current	See table
Line Regulation	Single&Dual: $\pm 0.5\%$, max.
Load Regulation	Single (0% to 100%): $\pm 0.5\%$, max. Dual (0% to 100%): $\pm 1\%$, max(balanced load)
Cross Regulation (1)	Dual: $\pm 5\%$
Ripple&Noise (2)	3.3V&5.0V : 100mVpk-pk,max. other : 150mVpk-pk,max.
Over Voltage Protection (Zener diode clamp)	3.3V output : 3.9V 5V output : 6.2V 12V output : 15V 15V output : 18V ± 12 V output : ± 15 V ± 15 V output : ± 18 V
Over Load Protection	115%~140% of lout max.
Short Circuit Protection	Indefinite(hiccup) (Automatic Recovery)
Temperature Coefficient	$\pm 0.02\%/^{\circ}\text{C}$
Capacitive Load (3)	See table
Transient Recovery Time (4)	250us, typ.
Transient Response Deviation (4)	$\pm 3\%$, max.

INPUT SPECIFICATIONS	
Input Voltage Range	See table
Under Voltage Lockout	
12V Models	Module ON / OFF : 8.6Vdc / 7.9Vdc, typ.
24V Models	Module ON / OFF : 17.8Vdc / 16Vdc, typ.
48V Models	Module ON / OFF : 33.5Vdc / 30.5Vdc, typ.
Start up Time (Nominal Vin and constant resistive load)	30mS, typ.
Input Filter	Pi Type
Input Current (No-Load)	See table, max.
Input Current (Full-Load)	See table, typ.
Input Reflected Ripple Current (5)	20mA _{p-p} , typ.
Remote On/Off (CTRL) (6)	
ON:	3.0 ... 12Vdc or open circuit
OFF:	0 ... 1.2Vdc or Short circuit pin2 and pin 3
OFF idle current:	5 mA, typ

GENERAL SPECIFICATIONS	
Efficiency	See table, typ.
I/O Isolation Voltage (3 sec)	
Input/Output	1600Vdc
Case/Input & Output	1600Vdc
Isolation Resistance	1000 M Ω , min.
Isolation Capacitance	1000 pF, typ.
Switching frequency	270kHz, typ.
Humidity	95% rel H
Reliability Calculated MTBF (MIL-HDBK-217 F)	Single&Dual: >328 khrs
Safety Standard (designed to meet)	IEC/EN 60950-1

EMC CHARACTERISTICS		
Radiated Emissions(7)	EN55022	CLASS B
Conducted Emissions(7)	EN55022	CLASS B
ESD	IEC61000-4-2	Perf. Criteria A
RS	IEC61000-4-3	Perf. Criteria A
EFT(8)	IEC61000-4-4	Perf. Criteria A
Surge (8)	IEC61000-4-5	Perf. Criteria A
CS	IEC61000-4-6	Perf. Criteria A
PFMF	IEC61000-4-8	Perf. Criteria A

PHYSICAL SPECIFICATIONS	
Case Material	Nickel-coated Copper
Base Material	Non-conductive Black Plastic(UL94V-0 rated)
Pin Material	$\varnothing 1.0$ mm Brass Solder-coated
Potting Material	Epoxy (UL94V-0 rated)
Weight	32.0g
Dimensions	2.00"x1.00"x0.40"

ABSOLUTE SPECIFICATIONS (9)	
These are stress ratings. Exposure of devices to any of these conditions may adversely affect long-term reliability.	
Input Surge Voltage (100mS)	
12 Models	25 Vdc max.
24 Models	50 Vdc max.
48 Models	100 Vdc max.
Soldering Temperature (1.5mm from case 10 sec. Max.)	260°C max.

ENVIRONMENTAL SPECIFICATIONS	
Operating Ambient Temperature	-40°C ~ +71°C(See Derating Curve)
12 Models	-40°C ~ +45°C(For 100% load)
24 / 48 Models	-40°C ~ +50°C(For 100% load)
Maximum Case Temperature	105°C
Storage Temperature	-55°C ~ +125°C

ST - 40W 2:1 Regulated Single & Dual output

PART NUMBER STRUCTURE

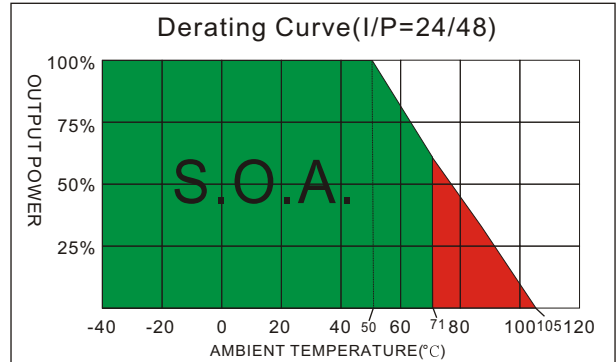
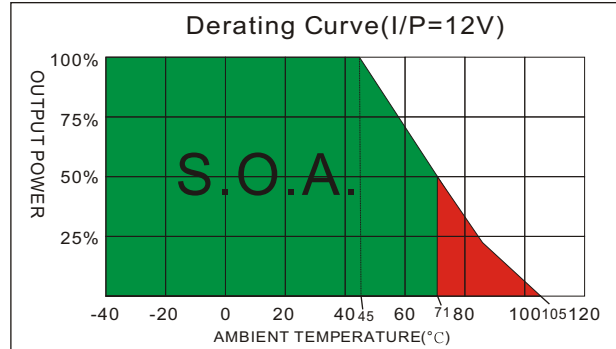
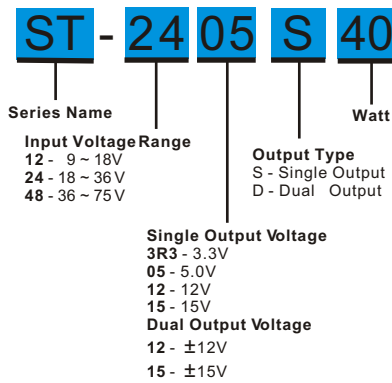

MODEL SELECTION GUIDE

MODEL NUMBER	INPUT Voltage Range (Vdc)	INPUT Current		OUTPUT Voltage (Vdc)	OUTPUT Current		EFFICIENCY @FL(%)	Capacitor Load(uF)
		No-Load (mA)	Full Load (mA)		Min-Lo ad (mA)	Full Load (mA)		
ST-123R3S40	9-18	100	2444	3.3	0	8000	90	21800
ST-1205S40	9-18	160	3663	5	0	8000	91	13600
ST-1212S40	9-18	40	3663	12	0	3333	91	2300
ST-1215S40	9-18	50	3663	15	0	2666	91	1500
ST-243R3S40	18-36	60	1208	3.3	0	8000	91	21800
ST-2405S40	18-36	90	1811	5	0	8000	92	13600
ST-2412S40	18-36	30	1831	12	0	3333	91	2300
ST-2415S40	18-36	40	1811	15	0	2666	92	1500
ST-483R3S40	36-75	40	604	3.3	0	8000	91	21800
ST-4805S40	36-75	60	905	5	0	8000	92	13600
ST-4812S40	36-75	20	915	12	0	3333	91	2300
ST-4815S40	36-75	20	905	15	0	2666	92	1500
ST-1212D40	9-18	50	3663	±12	0	±1666	91	±1200
ST-1215D40	9-18	50	3623	±15	0	±1333	92	±750
ST-2412D40	18-36	50	1831	±12	0	±1666	91	±1200
ST-2415D40	18-36	40	1811	±15	0	±1333	92	±750
ST-4812D40	36-75	30	906	±12	0	±1666	92	±1200
ST-4815D40	36-75	40	906	±15	0	±1333	92	±750

NOTE

1. Dual: One load is 25% to 100% load, the other load is 100% load, the output voltage variable rate is within ±5%.
2. Measured with 20MHz bandwidth and 1.0uF ceramic capacitor.
3. Tested by minimal Vin and constant resistive load.
4. Tested by normal Vin and 25% load step change (75%-50%-25% of Io).
5. Measured Input reflected ripple current with a simulated source inductance of 12uH.
6. The remote on/off control pin is referenced to -Vin(pin2).
7. The ST-40W series can meet EN55022 Class B With an external filter in parallel with the input pins .
8. An external filter capacitor is required if the module has to meet IEC61000-4-4 and IEC61000-4-5.
The filter capacitor Schmid-M suggest: Nippon chemi-con KY series, 220uF/100V
9. Exceeding the absolute ratings of the unit could cause damage.
It is not allowed for continuous operating.

TEST CONFIGURATIONS

Input Reflected Ripple Current Test Step

Input reflected ripple current is measured through a source inductor L_{in} (4.7uH) and a source capacitor C_{in} (47uF, ESR<1.0Ω at 100KHz) at nominal input and full load.

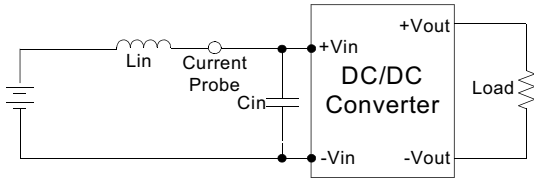

Output Ripple & Noise Measurement Test

Use a capacitor C_{out} (1.0uF) measurement. The Scope measurement bandwidth is 0-20MHz.

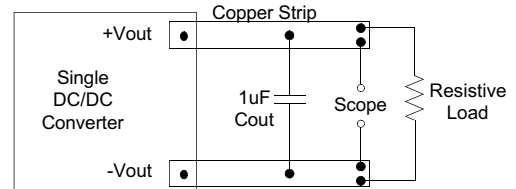

DESIGN & FEATURE CONFIGURATIONS

Output Ripple & Noise Reduction

To reduce ripple and noise, it is recommended to use a 1uF ceramic disk capacitor and a 10uF electrolytic

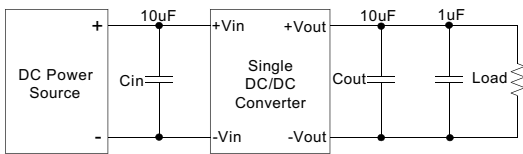

CTRL Module ON / OFF

Positive logic turns on the module during high logic and Off during low logic. Ctrl module on/off can be controlled by an external switch between the ctrl terminal and -Vin terminal. the switch can be an open collector or open drain for positive logic if the ctrl feature is not used, please leave the ctrl pin floating.

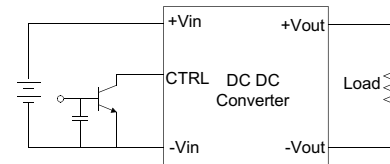

EMI Filter

Input filter components are used to help meet conducted emissions requirement for the module. These components should be mounted as close as possible to the module; and all leads should be minimized to decrease radiated noise.

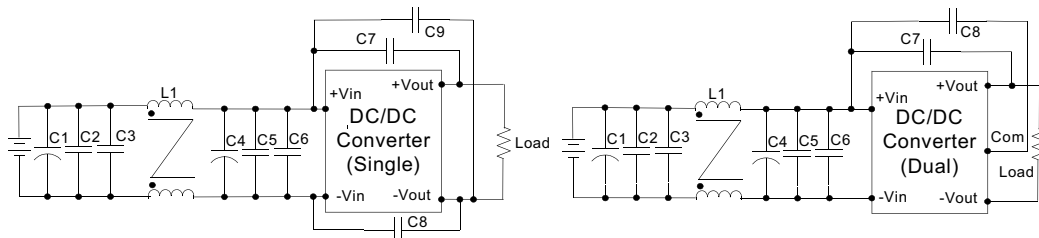

Single	C1	L1	C2/C3/C5/C6	C4	C7	C8	C9
ST-12XXXSXX	220uF, 100V	Common Choke 68uH	1812,6.8uF, 50V	330uF, 100V			1206,1000PF, 2KV
ST-24XXXSXX	220uF, 100V	Common Choke 68uH	1812,4.7uF, 50V	220uF, 100V	1206,1000PF, 2KV	1206,1000PF, 2KV	
ST-48XXXSXX	220uF, 100V	Common Choke 68uH	1812,1.5uF, 100V	220uF, 100V	1206,1000PF, 2KV	1206,1000PF, 2KV	
Dual	C1	L1	C2/C3/C5/C6	C4	C7	C8	
ST-12XXXDXX	220uF, 100V	Common Choke 68uH	1812,6.8uF, 50V	330uF, 100V	1206,1000PF, 2KV	1206,1000PF, 2KV	
ST-24XXXDXX	220uF, 100V	Common Choke 68uH	1812,4.7uF, 50V	220uF, 100V	1206,1000PF, 2KV	1206,1000PF, 2KV	
ST-48XXXDXX	220uF, 100V	Common Choke 68uH	1812,1.5uF, 100V	220uF, 100V	1206,1000PF, 2KV	1206,1000PF, 2KV	

ELECTRICAL CHARACTERISTIC CURVES

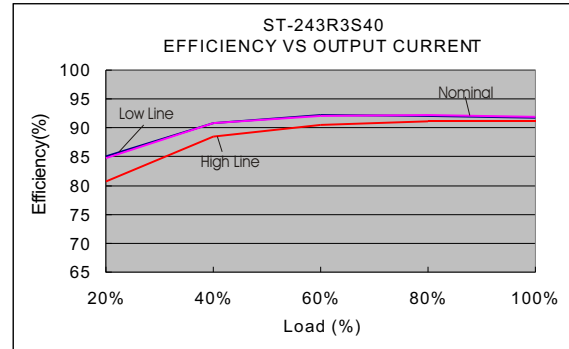
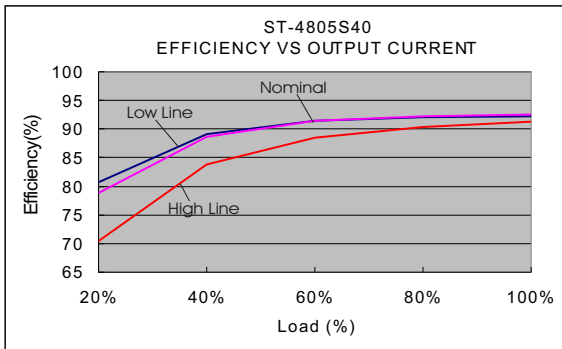
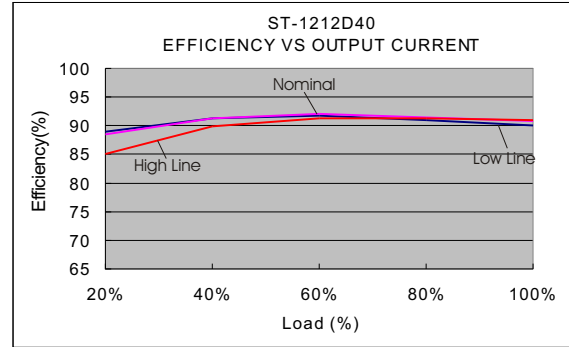
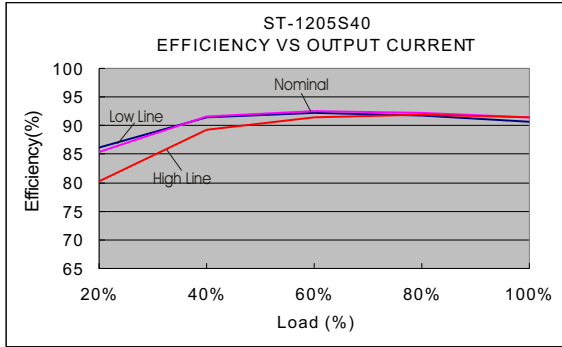

MECHANICAL SPECIFICATIONS

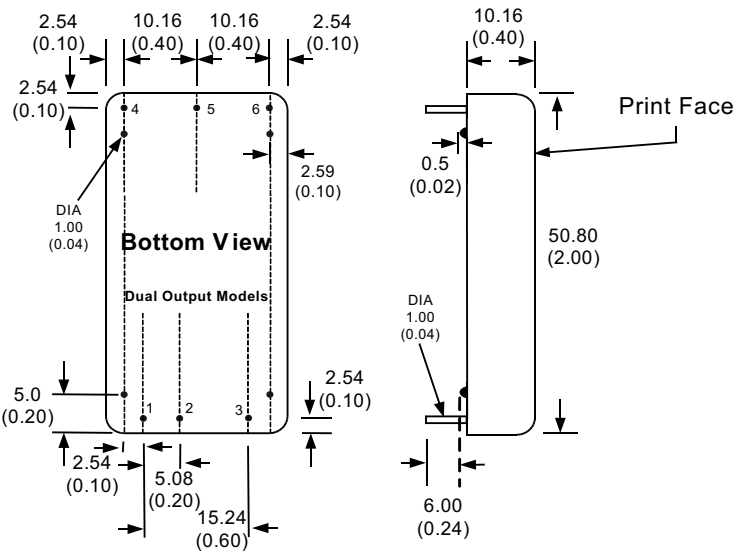

PIN CONNECTIONS		
PIN NUMBER	SINGLE	DUAL
1	+Vin	+Vin
2	-Vin	-Vin
3	CTRL	CTRL
4	+Vout	+Vout
5	-Vout	Com
6	Trim	-Vout

EXTERNAL OUTPUT TRIMMING

Output can be externally trimmed by using the method as below. (single output models only)

Rtrim-up

Rtrim-down

- All dimensions are typical in millimeters (inches).
1. Pin diameter: 1.0 ±0.05 (0.04 ±0.002)
 2. Pin pitch and length tolerance: ±0.35 (±0.014)
 3. Case Tolerance: ±0.5 (±0.02)
 4. Stand-off Tolerance: ±0.1 (±0.004)