



SK-2W Series DC/DC-Converter

2W 4:1 Regulated Single & Dual output

Features

- Wide 4:1 Input Range
- Full SMD Technology
- 1500 VDC Isolation, Up to 3500 VDC
- Continuous Short Circuit Protection
- Efficiency up to 78%
- -40 ~ 85°C Operation Temperature Range
- Metal Case Standard, Optional Plastic Case
- EMI Complies With EN55022 Class A



The SK series is a family of cost effective 2W single & dual output DC-DC converters. These converters are consisted with Nickle-coated copper in a 24-pin DIL package with high performance features such as 1500 VDC ~ 3500VDC input/output isolation voltage, continuous short circuit protection with automatic restart and tight line / load regulation. Devices are encapsulated using flame retardant resin. Input voltages of 24 and 48 with output voltage of 3.3, 5, 7.2, 9, 12, 15, 18, 24, ± 3.3 , ± 5 , ± 7.2 , ± 9 , ± 12 , ± 15 , ± 18 and ± 24 Vdc. High performance features include high efficiency operation up to 78% and output voltage accuracy of $\pm 1\%$ maximum.

All specifications typical at $T_a=25^\circ\text{C}$, nominal input voltage and full load unless otherwise specified

OUTPUT SPECIFICATIONS		EMC SPECIFICATIONS		
Voltage accuracy	$\pm 1\%$	Radiated Emissions	EN55022	CLASS A
Line regulation	$\pm 0.5\%$	Conducted Emissions(4)	EN55022	CLASS A
Load regulation	$\pm 0.5\%$	ESD	IEC 61000-4-2	Perf. Criteria B
	(Output 3.3V / $\pm 3.3\text{V}$ Model) $\pm 1.5\%$	RS	IEC 61000-4-3	Perf. Criteria A
Ripple & noise(20 MHz bandwidth)(1)	60mV pk-pk	EFT	IEC 61000-4-4	Perf. Criteria B
Short circuit protection	Indefinite(Automatic Recovery)	CS	IEC 61000-4-6	Perf. Criteria A
Temperature coefficient	$\pm 0.02\%/^\circ\text{C}$	PfMF	IEC 61000-4-8	Perf. Criteria A
Capacitor load(2)	See table			
INPUT SPECIFICATIONS		PHYSICAL SPECIFICATIONS		
Voltage Range	See table	Case Material	Nickel-coated Copper	
Max. Input Current	See table		Non-conductive Black Plastic(UL94V-0 rated)	
No-Load Input Current	See table	Base Material	Non-conductive Black Plastic(UL94V-0 rated)	
Input Filter	PI Type	Pin Material	$\varnothing 0.5\text{mm}$ Brass Solder-coated	
Input Reflected Ripple Current(3)	35mA pk-pk	Potting Material	Epoxy (UL94V-0 rated)	
		Weight	17.0g(Metal Case)/13.5g(Plastic Case)	
		Dimensions	1.25"x0.8"x0.4"	
GENERAL SPECIFICATIONS		ENVIRONMENT SPECIFICATIONS		
Efficiency	See table, typ	Operating Temperature	$-40^\circ\text{C} \sim 85^\circ\text{C}$ (See Derating Curve)	
I/O Isolation Voltage(3 sec)		Maximum Case Temperature	100°C	
Input/Output	1500~3500Vdc	Storage Temperature	$-40^\circ\text{C} \sim 125^\circ\text{C}$	
Metal Case/Input & Output	1000Vdc	Cooling	Nature Convection	
I/O Isolation Capacitance	500 pF Typ.			
I/O Isolation Resistance	1000M Ohm			
Switching Frequency	Typical 266kHz			
Humidity	95% rel H			
Reliability Calculated MTBF(MIL-HDBK-217 F)	>1.121 Mhrs			
Safety Standard : (designed to meet)	IEC 60950-1:2001			
		ABSOLUTE MAXIMUM RATINGS(5)		
		These are stress ratings. Exposure of devices to any of these conditions may adversely affect long-term reliability.		
		Input Voltage(100mS)		
		24 Modes	$-0.7 \sim 40$ Vdc	
		48 Modes	$-0.7 \sim 80$ Vdc	
		Lead Soldering Temperature	260°C	
		(1.5mm from case 10sec.)		



PART NUMBER STRUCTURE

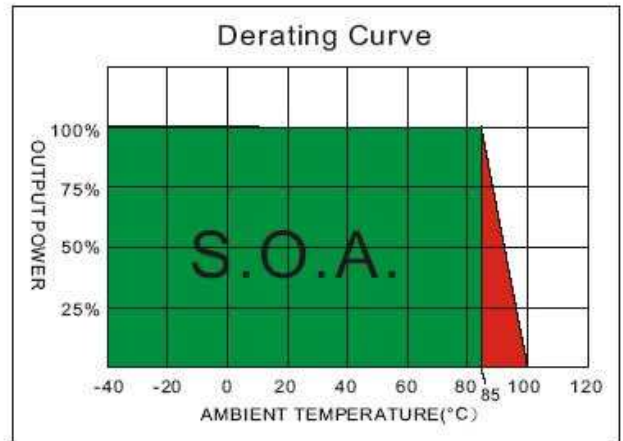
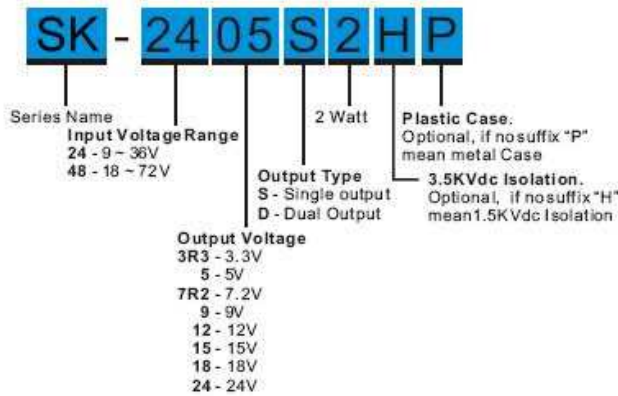

MODEL SELECTION GUIDE

MODEL NUMBER	INPUT Voltage Range (Vdc)	INPUT Current		OUTPUT Voltage (Vdc)	OUTPUT Current		EFFICIENCY @FL(%)	Capacitor Load(uF)
		No-Load (mA)	Full Load (mA)		Min. load (mA)	Full load (mA)		
SK-243R3S2	9-36	15	110	3.3	0	600	75	470
SK-2405S2	9-36	15	109.6	5	0	400	76	330
SK-247R2S2	9-36	15	106.8	7.2	0	277	78	68
SK-2409S2	9-36	15	106.8	9	0	222	78	68
SK-2412S2	9-36	15	106.8	12	0	166	78	47
SK-2415S2	9-36	15	106.8	15	0	133	78	22
SK-2418S2	9-36	15	106.8	18	0	111	78	22
SK-2424S2	9-36	15	106.8	24	0	83	78	10
SK-243R3D2	9-36	15	110	±3.3	0	±303	75	±220
SK-2405D2	9-36	15	109.6	±5	0	±200	76	±100
SK-247R2D2	9-36	15	106.8	±7.2	0	±138	78	±33
SK-2409D2	9-36	15	106.8	±9	0	±111	78	±33
SK-2412D2	9-36	15	106.8	±12	0	±83	78	±22
SK-2415D2	9-36	15	106.8	±15	0	±66	78	±10
SK-2418D2	9-36	15	106.8	±18	0	±55	78	±10
SK-2424D2	9-36	15	106.8	±24	0	±41	78	±10
SK-483R3S2	18-72	12	55	3.3	0	600	75	470
SK-4805S2	18-72	12	54.82	5	0	400	76	330
SK-487R2S2	18-72	12	53.4	7.2	0	277	78	68
SK-4809S2	18-72	12	53.4	9	0	222	78	68
SK-4812S2	18-72	12	53.4	12	0	166	78	47
SK-4815S2	18-72	12	53.4	15	0	133	78	22
SK-4818S2	18-72	12	53.4	18	0	111	78	22
SK-4824S2	18-72	12	53.4	24	0	83	78	10
SK-483R3D2	18-72	12	55.5	±3.3	0	±303	75	±220
SK-4805D2	18-72	12	54.82	±5	0	±200	76	±100
SK-487R2D2	18-72	12	53.4	±7.2	0	±138	78	±33
SK-4809D2	18-72	12	53.4	±9	0	±111	78	±33
SK-4812D2	18-72	12	53.4	±12	0	±83	78	±22
SK-4815D2	18-72	12	53.4	±15	0	±66	78	±10
SK-4818D2	18-72	12	53.4	±18	0	±55	78	±10
SK-4824D2	18-72	12	53.4	±24	0	±41	78	±10

Suffix "H" means 3.5KVdc isolation
 Suffix "P" means Plastic case instead of standard Metal Case

NOTE

1. Typical value at nominal input voltage and full load.
2. Test by nominal input voltage and constant resistor load.
3. Measured Input reflected ripple current with a simulated source inductance of 12uH.
4. It's recommended to add C1(68 F), C2(33 F), L(12 H) in input end to achieve EN55022 conducted Class A.

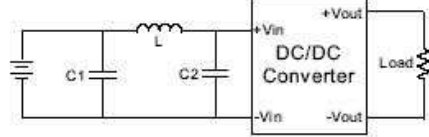

5. Exceeding the absolute ratings of the unit could cause damage. It is not allowed for continuous operating.

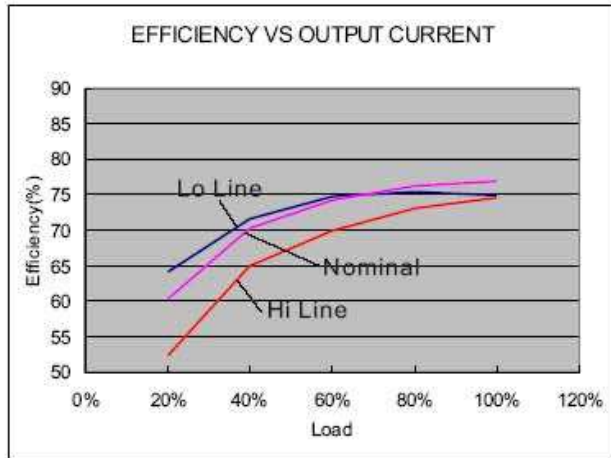

24 Models

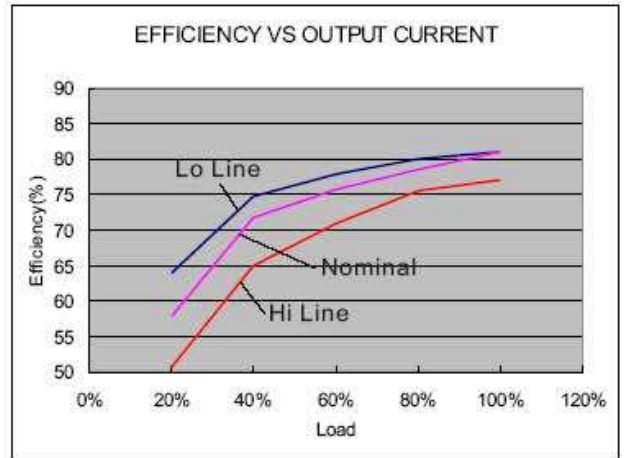

48 Models

MECHANICAL SPECIFICATIONS

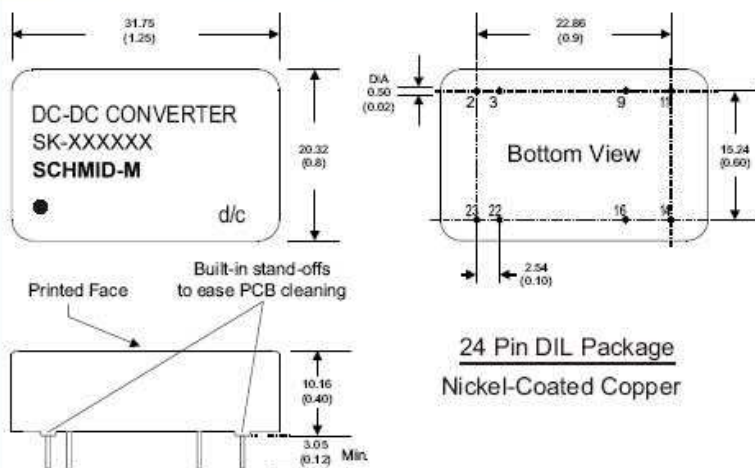

24 Pin DIL Package
Nickel-Coated Copper

- Notes: All dimensions are typical in millimeters (inches).
1. Pin diameter: 0.5 ±0.05 (0.02 ±0.002)
 2. Pin pitch tolerance: ±0.35 (±0.014)
 3. Case Tolerance: ±0.5 (±0.02)

PIN CONNECTIONS

PIN NUMBER	SINGLE	DUAL
2	-V Input	-V Input
3	-V Input	-V Input
9	N.P.	Common
11	N.C.	-V Output
14	+V Output	+V Output
16	-V Output	Common
22	+V Input	+V Input
23	+V Input	+V Input

(The Pin Connection of high isolation one is the same with normal one.)

MECHANICAL SPECIFICATIONS

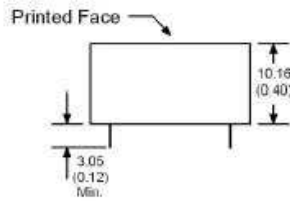
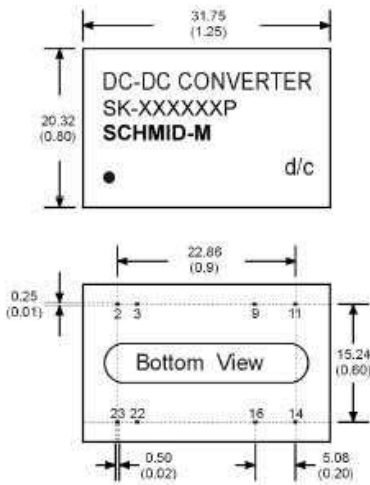

For "P" Case

24 Pin DIL Package
Non-Conductive Plastic

- Notes: All dimensions are typical in millimeters (inches).
1. Pin diameter: 0.5 ±0.05 (0.02 ±0.002)
 2. Pin pitch tolerance: ±0.35 (±0.014)
 3. Case Tolerance: ±0.5 (±0.02)

PIN CONNECTIONS		
PIN NUMBER	SINGLE	DUAL
2	-V Input	-V Input
3	-V Input	-V Input
9	N.P.	Common
11	N.C.	-V Output
14	+V Output	+V Output
16	-V Output	Common
22	+V Input	+V Input
23	+V Input	+V Input

(The Pin Connection of high isolation one is the same with normal one.)