

# SIF\_RN-1W & SIF\_RT-1W Series

**1W, FIXED INPUT, ISOLATED & REGULATED  
SINGLE OUTPUT, DC-DC CONVERTER**

**SCHMID-M**<sup>®</sup>  
DC/DC - Converter



## FEATURES

Small Footprint, Very thin package  
3KVDC Isolation  
Temperature Range: -40°C to +85°C  
No Heat sink Required  
High Power Density  
No External Component Required  
Industry Standard Pinout  
Pin-out compatible with DCP01 Series  
Short circuit protection  
RoHS Compliance

## PRODUCT PROGRAM

Part Number	Input		Output			Efficiency (% Typ.)	Package
	Voltage (VDC)		Voltage (VDC)	Current (mA)			
	Nominal	Range		Max	Min		
SIF0505RN-1W	5	4.75-5.25	5	200	20	70	DIP
SIF0505RT-1W			5	200	20	70	SMD

## APPLICATIONS

The SIF\_RN-1W & SIF\_RT-1W Series are specially designed for applications where a group of polar power supplies are isolated from the input power supply in a distributed power supply system on a circuit board.

These products apply to:

- 1) Where the voltage of the input power supply is fixed (voltage variation  $\leq \pm 5\%$ );
- 2) Where isolation is necessary between input and output (isolation voltage  $\leq 3000\text{VDC}$ );
- 3) Where the regulation of the output voltage and the output ripple noise are not demanding.

Such as: purely digital circuits, ordinary low frequency analog circuits, and IGBT power device driving circuits.

## COMMON SPECIFICATION

Item	Test Conditions	Min	Typ.	Max	Units
Storage humidity				95	%
Operating temperature		-40		85	°C
Storage temperature		-55		125	
Temp. rise at full load			15	25	
Lead temperature	1.5mm from case for 10 seconds			260	
Short circuit protection		Continuous			
Cooling		Free air convection			
Package material		Epoxy Resin(UL94-V0)			
MTBF		3500			K hours
Weight			1.4		g

## ISOLATION SPECIFICATIONS

Item	Test Conditions	Min	Typ.	Max	Units
Isolation voltage	Tested for 1 minute and 1mA max	3000			VDC
Isolation resistance	Test at 500VDC	1000			MΩ
Isolation Capacitance			25		pF

## MODEL SELECTION

SIF0505RN-1W

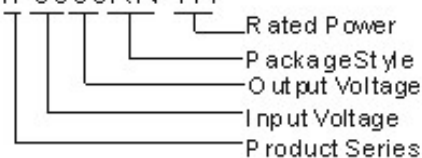

## OUTPUT SPECIFICATIONS

Item	Test Conditions	Min	Typ.	Max	Units
Output power		0.1		1	W
Line regulation	For Vin change of $\pm 5\%$			$\pm 0.25$	%
Load regulation	10% to 100% load			$\pm 1$	
Output voltage accuracy	100% full load			$\pm 3$	
Temperature drift	Nominal input, 100% full load			0.03	%/°C
Ripple *	20MHz Bandwidth		10	20	mVp-p
Noise *	20MHz Bandwidth		50	75	
Switching frequency	Full load, nominal input		100		KHz

\*Test ripple and noise by "parallel cable" method. See detailed operation instructions at Testing of Power Converter section, application notes.

Note:

1. All specifications measured at  $T_A=25^\circ\text{C}$ , humidity<75%, nominal input voltage and rated output load unless otherwise specified.
2. See below recommended circuits for more details.

## TYPICAL CHARACTERISTICS

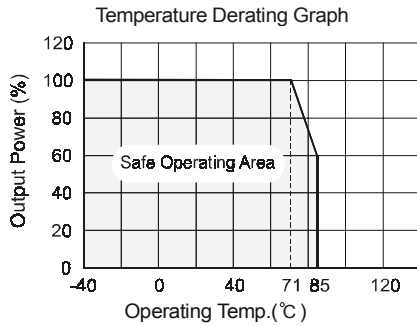

## RECOMMENDED REFLOW SOLDERING PROFILE

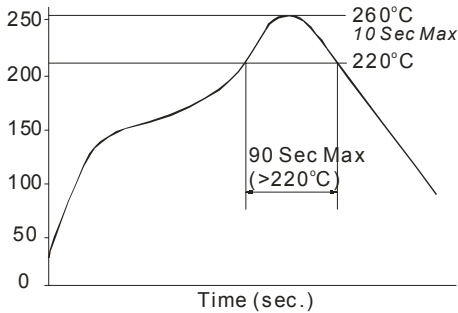

## OUTLINE DIMENSIONS & FOOTPRINT DETAILS

First Angle Projection

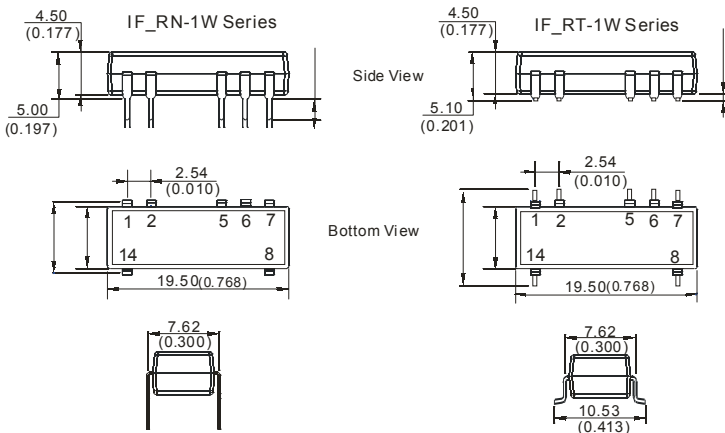

RECOMMENDED FOOTPRINT  
Top view, grid: 2.54\*2.54mm (0.1\*0.1inch)

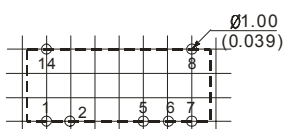

### FOOTPRINT DETAILS

Pin	Function
1	Vin
2	GND
5	0V
6	+Vo
7,8,14	NC

NC: No Connection

Note:  
Unit: mm (inch)  
Pin section: 0.50\*0.25mm (0.020\*0.010inch)  
Pin section tolerances: ±0.10mm (±0.004inch)  
General tolerances: ±0.25mm (±0.006inch)

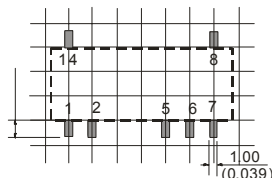

Pin	Function
1	Vin
2	GND
5	0V
6	+Vo
7,8,14	NC

NC: No Connection

## APPLICATION NOTE

### Requirement on output load

To ensure this module can operate efficiently and reliably, During operation, the minimum output load is **not less than 10%** of the full load, and that **this product should never be operated under no load!** If the actual output power is very small, please connect a resistor with proper resistance at the output end in parallel to increase the load, or use our company's products with a lower rated output power.

### Recommended testing circuit

If you want to further decrease the input/output ripple, an "LC" filtering network may be connected to the input and output ends of the DC/DC converter, see (Figure 1).

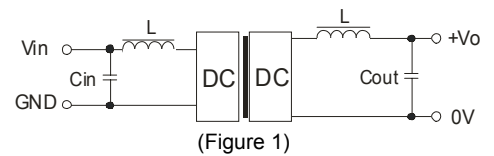

It should also be noted that the inductance and the frequency of the "LC" filtering network should be staggered with the DC/DC frequency to avoid mutual interference. However, the capacitance of the output filter capacitor must be proper. If the capacitance is too big, a startup problem might arise. For every channel of output, provided the safe and reliable operation is ensured, the greatest capacitance of its filter capacitor sees (Table 1).

EXTERNAL CAPACITOR TABLE (Table 1)

Vin (VDC)	Cin (uF)	Vout (VDC)	Cout (uF)
5	4.7	5	4.7

It's not recommend to connect any external capacitor in the application field with less than 0.5 watt output.

### Overload Protection

Under normal operating conditions, the output circuit of these products has no protection against over load. The simplest method is to connect a self-recovery fuse in series at the input end or add a circuit breaker to the circuit.

### Input Over-voltage Protection Circuit

The simplest device for input over-voltage protection is a linear voltage regulator with overheat protection that is connected to the input end in series (Figure2).

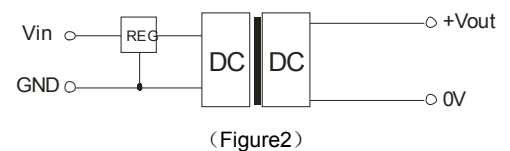

**No parallel connection or plug and play.**