



SE_S-1W/ E_D-1W Series

FIXED INPUT ISOLATED & UNREGULATED 1W OUTPUT DUAL OUTPUT MINIATURE SIP(DIP) PACKAGE



FEATURES

- High Efficiency up to 81%
- Positive & Negative Voltage Output
- Small Footprint
- 7PIN SIP/14 PIN DIP Package
- Industry Standard Pinout
- UL94-V0 Package
- No Heat sink Required
- 3kVDC Isolation
- Power Density 0.85W/cm³
- Temperature Range: -40°C~+85°C
- No External Component Required
- RoHS Compliance

APPLICATIONS

The SE_S/D-1W Series are specially designed for applications where a group of polar power supplies are isolated from the input power supply in a distributed power supply system on a circuit board.

These products apply to:

- 1) Where the voltage of the input power supply is fixed (voltage variation $\leq \pm 10\%$);
- 2) Where isolation is necessary between input and output (isolation voltage = 3000VDC);
- 3) Where the regulation of the output voltage and the output ripple noise are not demanding.

Such as: purely digital circuits, ordinary low frequency analog circuits, and IGBT power device driving circuits.

MODEL SELECTION

SE0505S-1W

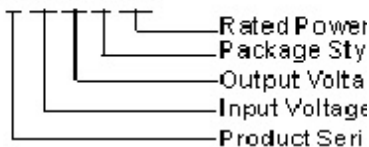

PRODUCT PROGRAM

Part Number	Input		Output			Efficiency (% Typ)	Package Style
	Voltage (VDC)		Voltage (VDC)	Current (mA)			
	Nominal	Range		Max	Min		
SE0505S/D-1W	5	4.5~5.5	±5	±100	±10	72	SIP/DIP
SE0509S/D-1W	5	4.5~5.5	±9	±56	±6	75	SIP/DIP
SE0512S/D-1W	5	4.5~5.5	±12	±42	±5	78	SIP/DIP
SE0515S/D-1W	5	4.5~5.5	±15	±33	±4	79	SIP/DIP
SE1205S/D-1W	12	10.8~13.2	±5	±100	±10	74	SIP/DIP
SE1209S/D-1W	12	10.8~13.2	±9	±56	±6	76	SIP/DIP
SE1212S/D-1W	12	10.8~13.2	±12	±42	±5	79	SIP/DIP
SE1215S/D-1W	12	10.8~13.2	±15	±33	±4	80	SIP/DIP
SE2405S/D-1W	24	21.6~26.4	±5	±100	±10	74	SIP/DIP
SE2409S/D-1W	24	21.6~26.4	±9	±56	±6	76	SIP/DIP
SE2412S/D-1W	24	21.6~26.4	±12	±42	±5	80	SIP/DIP
SE2415S/D-1W	24	21.6~26.4	±15	±33	±4	81	SIP/DIP

Note: The SE_S/D-0.25W series also are available in our company.

COMMON SPECIFICATIONS

Short circuit protection	1 second
Temperature rise at full load	25°C MAX, 15°C TYP
Cooling	Free air convection
Operating temperature range	-40°C~+85°C
Storage temperature range	-55°C ~+125°C
Lead temperature	300°C (1.5mm from case for 10 seconds)
Storage humidity range	≤ 95%
Case material	Plastic (UL94-V0)
MTBF	>3,500,000 hours

ISOLATION SPECIFICATIONS

Item	Test conditions	Min	Typ	Max	Units
Isolation voltage	Tested for 1 minute	3000			VDC
Isolation resistance	Test at 500VDC	1000			MΩ

OUTPUT SPECIFICATIONS

Item	Test conditions	Min	Typ	Max	Units
Output power		0.1		1	W
Line regulation	For Vin change of 1%			1.2	%
Load regulation	10% to 100% full load		10	15	%
Output voltage accuracy	See tolerance envelope graph				
Temperature drift	100% full load			0.03	%/°C
Output ripple	20MHz Bandwidth		100	150	mVp-p
Switching frequency	Full load, nominal input		100		KHz

Note:

1. All specifications measured at TA=25°C, humidity<75%, nominal input voltage and rated output load unless otherwise specified.
2. See below recommended circuits for more details.

TYPICAL CHARACTERISTICS

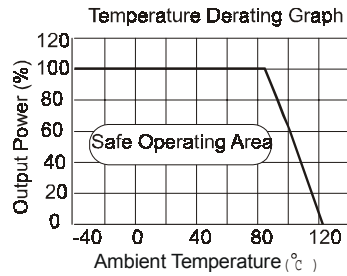
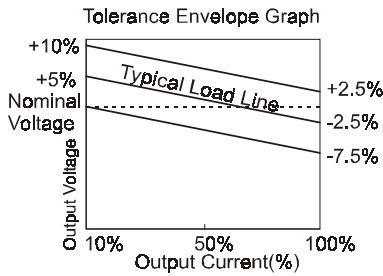

PIN CONNECTIONS

Pin	Function
1	V _{in}
2	GND
5	-V _o
6	0V
7	+V _o

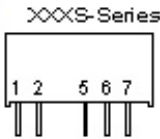

Pin	Function
1	GND
7	NC
8	+V _o
9	0V
10	-V _o
14	V _{in}

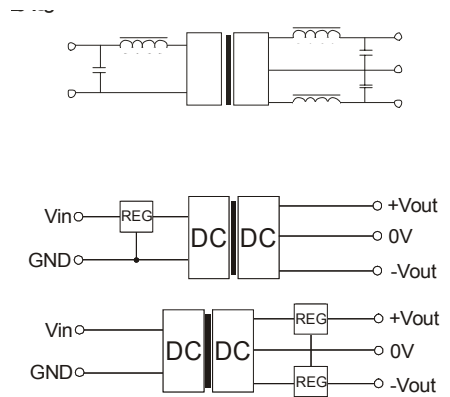
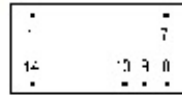

<Figure 2>

OUTLINE DIMENSIONS & RECOMMENDED FOOTPRINT DETAILS

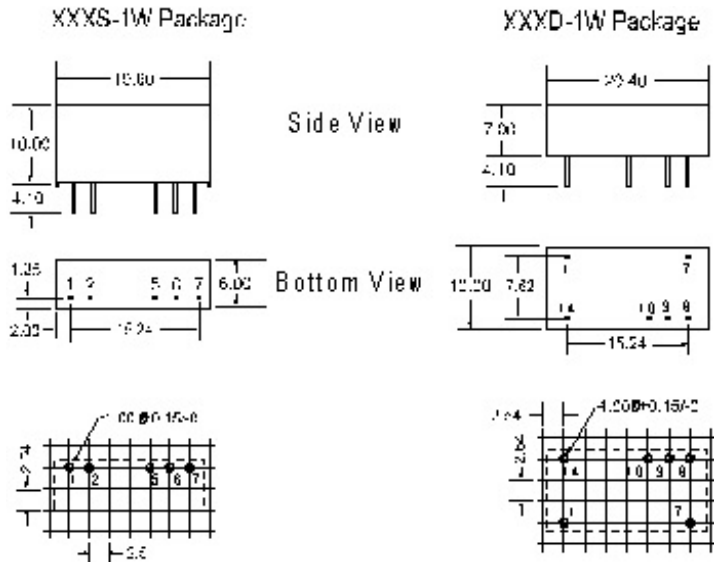

Note: All Pins on a 2.54mm pitch; all pin diameters are 0.50mm; all dimensions in mm.

APPLICATION NOTE

Filtering

In some circuits which are sensitive to noise and ripple, a filtering capacitor may be added to the DC/DC output end and input end to reduce the noise and ripple. However, the capacitance of the output filter capacitor must be proper. If the capacitance is too big, a startup problem might arise. For every channel of output, provided the safe and reliable operation is ensured, the greatest capacitance of its filter capacitor sees the external capacitor table. To get an extremely low ripple, an "LC" filtering network may be connected to the input and output ends of the DC/DC converter, which may produce a more significant filtering effect. It should also be noted that the inductance and the frequency of the "LC" filtering network should be staggered with the DC/DC frequency to avoid mutual interference (see Figure 1).

Requirement on output load

To ensure this module can operate efficiently and reliably, a minimum load is specified for this kind of DC/DC converter in addition to a maximum load (namely full load). During operation, make sure the specified range of input voltage is not exceeded, the minimum output load is **not less than 10%** of the full load, and that this product should never be operated under no load! If the actual output power is very small, please connect a resistor with proper resistance at the output end in parallel to increase the load, or use our company's products with a lower rated output power (SE_S/D -0.25W series).

Overload Protection

Under normal operating conditions, the output circuit of these products has no protection against over-current and short-circuits. The simplest method is to connect a self-recovery fuse in series at the input end or add a circuit breaker to the circuit.

Output Voltage Regulation and Over-voltage Protection Circuit

The simplest device for output voltage regulation, over-voltage and over-current protection is a linear voltage regulator with overheat protection that is connected to the input or output end in series (see Figure 2).

External Capacitor Table

V _{in}	External capacitor	V _{out}	External capacitor
5VDC	4.7uF	5VDC	4.7uF
12VDC	2.2uF	9VDC	2.2uF
24VDC	1uF	12VDC	1uF
--	--	15VDC	0.47uF